

CLASSIC



CONTEMPORARY



CUSTOM



THE DOORLAND GROUP COLLECTION

SOLID WOOD STILE & RAIL DOORS MDF & FIRE RATED DOORS SOLID WOOD MOULDINGS

Making doors is our business.

Toll: 1.800.265.0379 Web: www.doorlandgroup.com

Built to Spec. Built for You.

Our Solid Wood **Stile & Rail** Doors

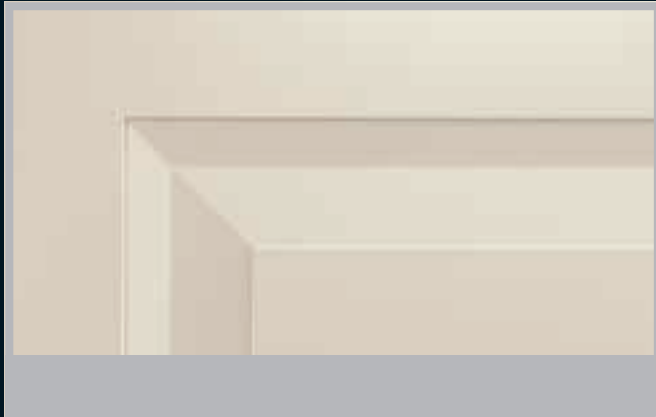

Our Solid **MDF & Fire Rated** Doors



Our Solid Wood **Mouldings**

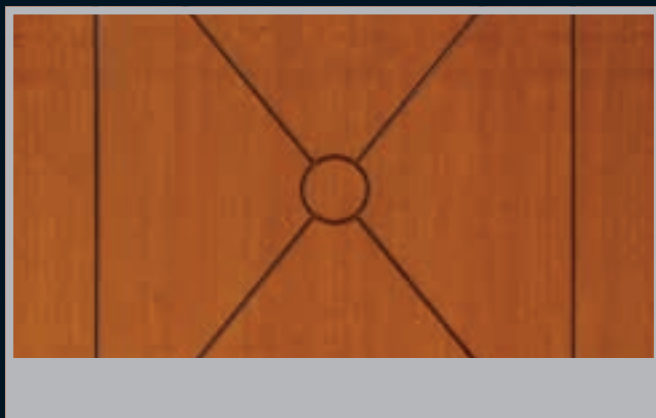

Our Superior **Factory Finish**

CONTENTS

Welcome to the Doorland Group	4		
Our History: From Past To Present	5		
Our Solid Wood Stile & Rail Doors	6		
Our Solid MDF Doors.....	6		
Our Solid Wood Mouldings & Trim.....	6		
Our Factory Finish	6		
Our Hardware	6		
Our Environment	7		
Our Solid MDF Doors	8		
Traditional Solid MDF Door Specifications	8		
The Wynn Encore Door, Guest Room Suite Side			
Factory Finish Solid MDF	9		
Factory Finish Solid MDF	10		
Factory Finish Solid MDF with Applied Moulding.....	11		
Stained Solid MDF.....	12		
Our Solid MDF Veneer Doors	13		
Natural Wenge Veneer.....	13		
Ash Veneer	14		
Rift-Cut White Oak Veneer.....	15		
Zebrano Wood Veneer.....	16		
Quarter Cut Cherry Veneer.....	17		
Pomele Burl Veneer.....	18		
Our Solid MDF Fire Rated Doors.....	19		
Our Solid MDF Fire Rated Doors Specifications.....	19		
Maple Veneer.....	20		
The Wynn & The Wynn Encore Suite Entry Door			
Factory Finish Solid MDF.....	21		
Our MDF Majestic Doors.....	22		
Majestic Custom Arch Top.....	23		
Our Solid Wood Stile & Rail Interior Doors	25		
Solid Wood Stile & Rail Door Specifications	25		
Interior American Poplar Stained Walnut.....	26		
Interior Paint Grade American Poplar.....	27		
Solid Walnut.....	28		
Solid Knotty Pine	29		
Solid Natural Walnut	30		
Solid Cherry with Light Curly Maple Panel	31		
Interior American Poplar Stain Grade.....	32		
Interior American Poplar Stain Grade.....	33		
		Our Solid Wood Stile & Rail French Interior Doors	34
		Interior American Poplar Stain Grade.....	35
		Interior American Poplar Stain Grade.....	36
		Factory Finish Pub Door in Solid African Mahogany.....	37
		Our Louver Doors.....	38
		Louver Doors Specifications	38
		Factory Finish Solid Walnut Vented Louver.....	39
		Factory Finish Solid Cherry Operable Louver	40
		Factory Finish Solid MDF False Louver.....	41
		Our Solid Wood Stile & Rail Exterior Doors	42
		Solid Wood Stile & Rail Exterior Door Specifications....	42
		Eagle's Nest Golf Club Mahogany Door	43
		Church Exterior Wood Oak Doors	44
		Custom Residential Solid Mahogany.....	45
		Custom Residential Oak.....	46
		Custom Residential Walnut.....	47
		Custom Residential Mahogany	48
		Custom Residential Oak.....	49
		Custom Residential Oak.....	50
		Night Club/Lounge Door Mahogany.....	51
		Custom Residential Horizontal Teak	52
		Our Mouldings.....	53
		How Mouldings are Produced.....	53
		Trim Moulding Profile Samples.....	54
		Fire Rated JAMB Specifications	56
		JAMB Specifications.....	57
		Our Factory Finish	58
		Factory Finish	59
		Our Door Elevation	60
		Door Styles.....	60
		Sticking & Panel Profiles.....	62
		Applied Moulding Profiles.....	63
		Our World Wide Projects.....	64



Welcome to the Doorland Group

Your answer to doors.

Our Doorland

The Doorland Group is an industry leader that creates custom wood stile & rail doors, MDF fire rated doors and wood mouldings. Each of our five divisions offers specialized door products and services for both commercial and residential applications.

Our Divisions

- Custom Solid Wood Stile & Rail Doors
- Custom MDF, 20, 45, 60 & 90 Minute Fire Rated Doors, up to STC 36
- Custom & Standard Mouldings
- Hardware
- In-House Automated Factory Finishing

There are several factors that make our doors unique. Not least of these is our ability to interpret any and all design plans in ways that express our clients' vision. Size, shape, color, finish, any element of our doors, can be adapted to blend with the chosen décor. Combine this ability with our superb craftsmanship, state-of-the-art machinery and software and, of course, the generations of knowledge that go into each piece we produce, and you will understand just how we have achieved our unrivalled reputation.



Our History: From Past

Doorland was founded by Elio Granzotto. Elio began his trade in Italy, where he was renowned as a classic art wood sculptor, specializing in fine intricate wood designs. His talents were well received by custom home builders and architects, who commissioned him to create entry-way systems, cabinetry and custom wood home décor.

Once he had completed his first custom door project, in 1978, Elio's success extended through the industry at large. His vision included a consultative approach, traditional work ethic, flexible design and strong client collaboration. In 1979, his vision was realized with the formation of Doorland Doors. Elio's natural craftsmanship and dedication were the beginning of a family tradition, one on which the company is still based. The values that were evident years ago are still part of The Doorland Group today.

To Present

Since its inception in 1979, Doorland has grown to a team of 125 employees, with a spacious 150,000 square foot facility that houses some of the industry's most advanced door and moulding manufacturing equipment.

Hand Crafted by Elio Granzotto in 1979



Our Solid Wood Stile & Rail Doors

Our solid wood stile & rail doors are made from top grade lumber and are assembled using a mortise and tenon joint. Strong and effective, this method produces one of the strongest joints in woodworking. Our door stiles are created from a single length of solid wood and are available in common and top grade wood species. These include; Red Oak, Yellow Poplar, Mahogany, Cherry, Walnut, Maple, and Knotty Pine.

Our manufacturing process uses the latest in computer numerical controlled (CNC) and custom-made machinery. We integrate the newest software applications and diamond tooling to ensure precision, consistency and supreme quality.

Our Solid MDF Doors

Our MDF doors are made from superior quality MDF with a solid wood door edge, which provides a superior grip during and after installation. Our MDF doors will not expand, contract, shrink, split or warp.

MDF doors are both beautiful and durable. They can be custom designed in any size with countless unique profiles and are also tested to comply with the requirements for 20, 45, 60 and 90 minute fire ratings and STC rating up to 36.

You can choose flat panels, raised panels or louvered doors and all styles are built using moisture-resistant type 1 glue and are factory primed on all six sides.

You'll find our doors in places of distinction throughout the world, including the Ritz-Carlton in Baltimore Maryland, the Plaza in New York, The Wynn and The Wynn Encore, Las Vegas.

Our Solid Wood Mouldings & Trim

Our solid wood mouldings can be manufactured in any specialty wood. We create our own templates and knives, which we cut and grind in-house. This gives our team greater control of the design and keeps the quality consistent during the manufacturing process. We have the ability to create customized profiles based on architectural and designer drawings.

Our Factory Finish

Our state-of-the-art factory finishing line is an automated process capable of finishing both interior and exterior doors in solid color, stain, sealer and lacquer.

Traditional trade finishing methods rely heavily on site conditions and workmanship. These factors can compromise the finish and the overall integrity of the door. The Doorland factory finished door is produced in a controlled environment; one where advanced machinery and qualified staff ensure a superior finish for each and every door.

Our Hardware

To further enhance the beauty of our doors, we offer a wide selection of entry sets and complimentary hardware. Add classical, contemporary and custom hardware in an assortment of finishes to your door design.

Our Environment

The Doorland Group prides itself on being environmentally responsible. Every possible effort is made to ensure that our suppliers embrace the same values and principles towards ecological sustainability, preservation of forests and the environment as a whole.

In an effort to reduce waste, our advanced dust and debris collection system produces the materials used in manufacturing animal stall flooring and particleboard. This system undergoes routine maintenance to ensure efficiency, and is compacted and collected twice daily.

Tree Planting Program

Our tree planting program will assist in restoring and replenishing our forests in both Canada and the United States. The Tree planting program is a joint initiative involving The Doorland Group and associated partners and suppliers. The objective is to ensure a sustainable forest supply, assist in combating global warming and to create a heightened awareness for our environment.

Enjoy the Great **Outdoors.**





Traditional Solid MDF Door Specifications

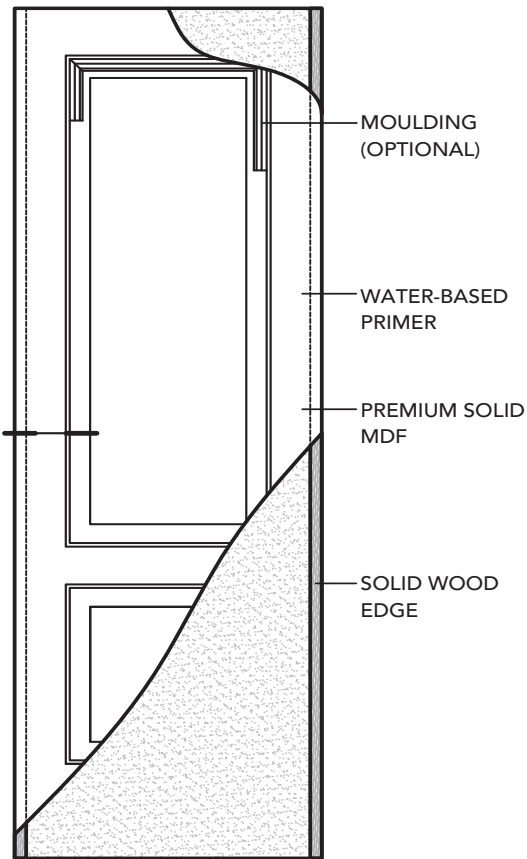
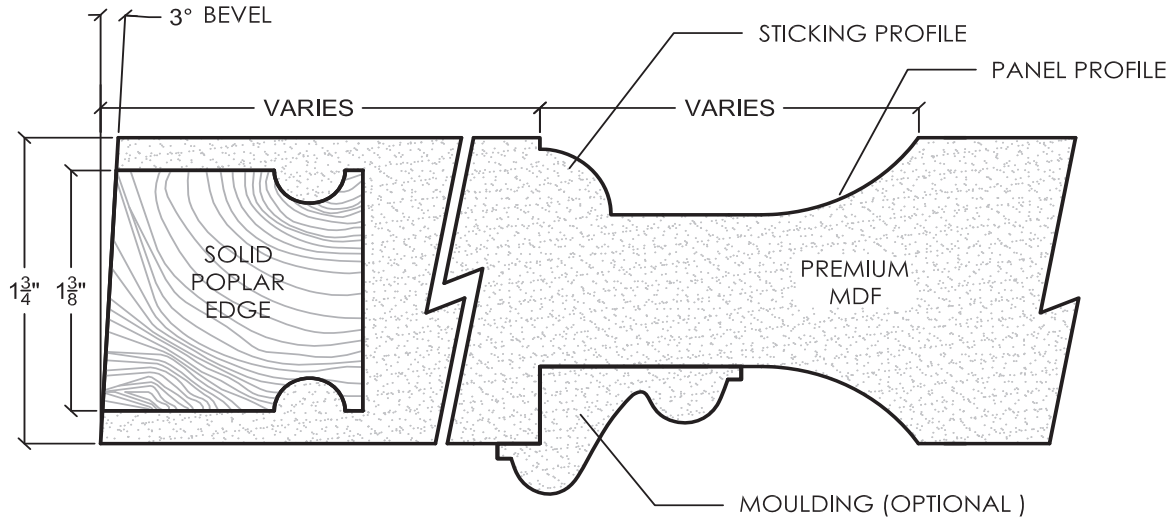

STANDARD DIMENSIONS:

THICKNESS	1-3/8", 1-3/4" & 2-1/4" (± 1/16")
WIDTH	1/4 - 4/0
HEIGHT	6/8, 7/0, 8/0

(Higher Doors Available Upon Request)

APPROXIMATE WEIGHT: (Based on 1 3/4" thickness)

	6/8	7/0	8/0
1/6	64	67	77
2/0	86	90	103
2/4	100	105	120
2/8	114	120	137
3/0	128	135	154

(in lbs)

MACHINING:

- * Factory-machining available to exacting requirements for hardware

FACTORY FINISH:

- * Doors are available with catalyzed varnish/polyurethane factory finish
- * Color choices are available or custom color matching by submitting a physical sample
- * All factory finished doors have sealed top & bottom rails

Available fire rated 20, 45, 60 & 90 minute
Available up to STC 36

Door Style DS-15

The Wynn Encore Door, Guest Room Suite Side Factory Finish Solid MDF



Trim Detail
Stained Poplar Century
CA303DL Casing &
B74DL Backband



Hardware Detail
Lock Style RP-106



Door Detail
Custom Brass Grill & Fabric Panel

Available fire rated 20, 45, 60 & 90 minute
Available up to STC 36



Door Style M-04
Factory Finish Solid MDF



Available fire rated 20, 45, 60 & 90 minute
Available up to STC 36



Trim Detail
Stained Poplar Century
CA303DL Casing &
B74DL Backband



Hardware Detail
Lock Style RP - 609



Door Detail
Quarter Round Sticking Royal Panel

Door Style M-09 with Applied Moulding
Factory Finish Solid MDF



Trim Detail
Paint Grade Poplar Julia
Casing CS402DL &
Custom MDF Header



Hardware Detail
Lock Style RP - 609



Door Detail
Barocco Applied Moulding
Royal Panel

Available fire rated 20, 45, 60 & 90 minute
Available up to STC 36



Door Style DS-16
Factory Finish Stained Solid MDF



Available fire rated 20, 45, 60 & 90 minute
Available up to STC 36

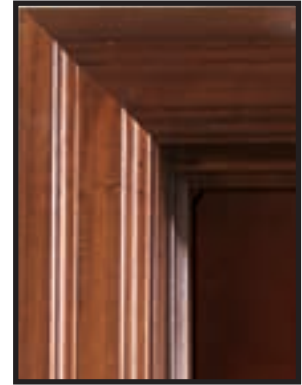

Trim Detail
Stained Mahogany Classic
Casing CA301DL



Hardware Detail
Lock Style MMII-P100



Door Detail
Modern Applied Moulding
Bevelled Panel

Door Style DS-8
Factory Finish Horizontal & Vertical Natural Wenge Veneer



Trim Detail
Painted Poplar Century
Casing CA303DL &
B74DL Backband



Hardware Detail
Lock Style RH-104

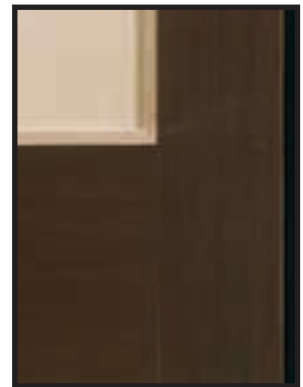

Door Detail
Quarter Cut Natural Maple Veneer
Inset with Solid Maple Square
Sticking Moulding

Available fire rated 20, 45, 60 & 90 minute
Available up to STC 36



Door Style DS-20

Factory Finish Horizontal & Vertical Grain Ash Veneer with Black Groove Detail



Trim Detail
Painted Poplar Century
Casing CA303DL &
B78DL Backband

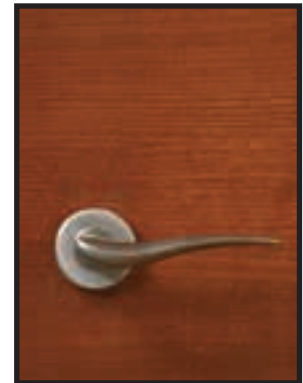

Hardware Detail
Lock Style RH-003

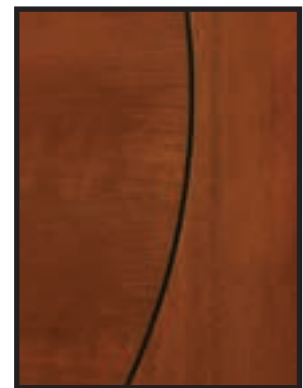

Door Detail
1/4" 'U' Groove

Available fire rated 20, 45, 60 & 90 minute
Available up to STC 36

Door Style DS-4
Rift-Cut White Oak Veneer



Trim Detail
Stained Rift-Cut White Oak
Groove Casing CA432DL



Hardware Detail
Lock Style MMII - P100



Door Detail
1/4" 'U' Groove

Available fire rated 20, 45, 60 & 90 minute
Available up to STC 36



Door Style G-11-4
Factory Finish Horizontal Grain Zebrano Wood Veneer with
Horizontal Edges and Groove Detail



Trim Detail
Stained Zebrano Wood
Groove Casing CA432DL



Hardware Detail
Lock Style MMII-P100



Door Detail
1/4" 'U' Groove

Available fire rated 20, 45, 60 & 90 minute
Available up to STC 36

Door Style DS-5
Factory Finish Quarter Cut Cherry Veneer



Trim Detail
Custom Cherry



Hardware Detail
Lock Style AR21-R

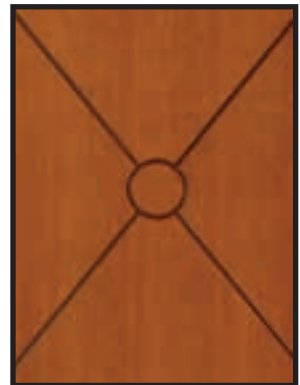

Door Detail
'V' Groove

Available fire rated 20, 45, 60 & 90 minute
Available up to STC 36



Door Style DS-11
Factory Finish Solid MDF with Pomele Burl Inset and MDF Grid Detail



Trim Detail
Painted Poplar Exclusive
Casing CA331DL &
B73DL Backband

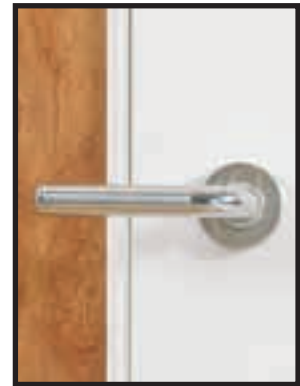

Hardware Detail
Lock Style RH-066



Door Detail
Custom-Applied MDF Grill
Shaker Veneer Panel

Available fire rated 20, 45, 60 & 90 minute
Available up to STC 36

Traditional MDF 20, 45, 60 & 90 Min Fire Rated Door Specifications

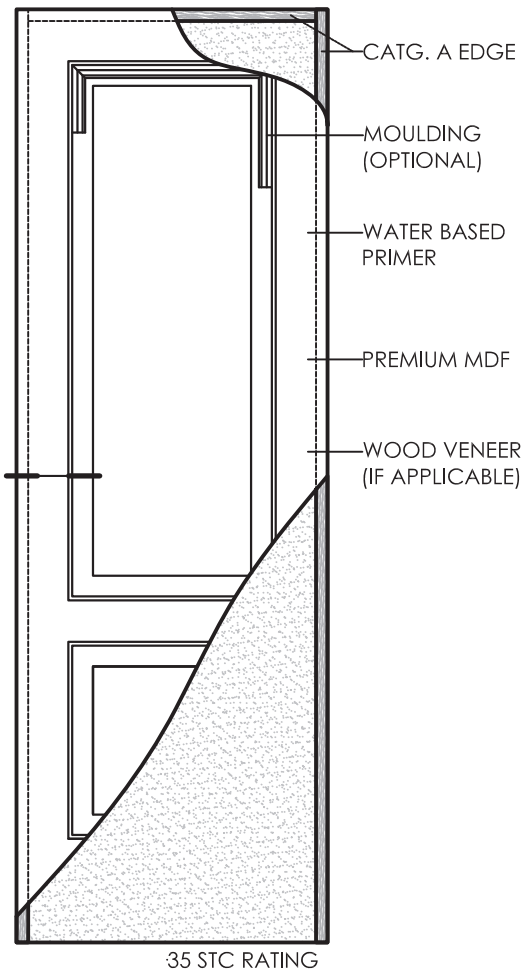
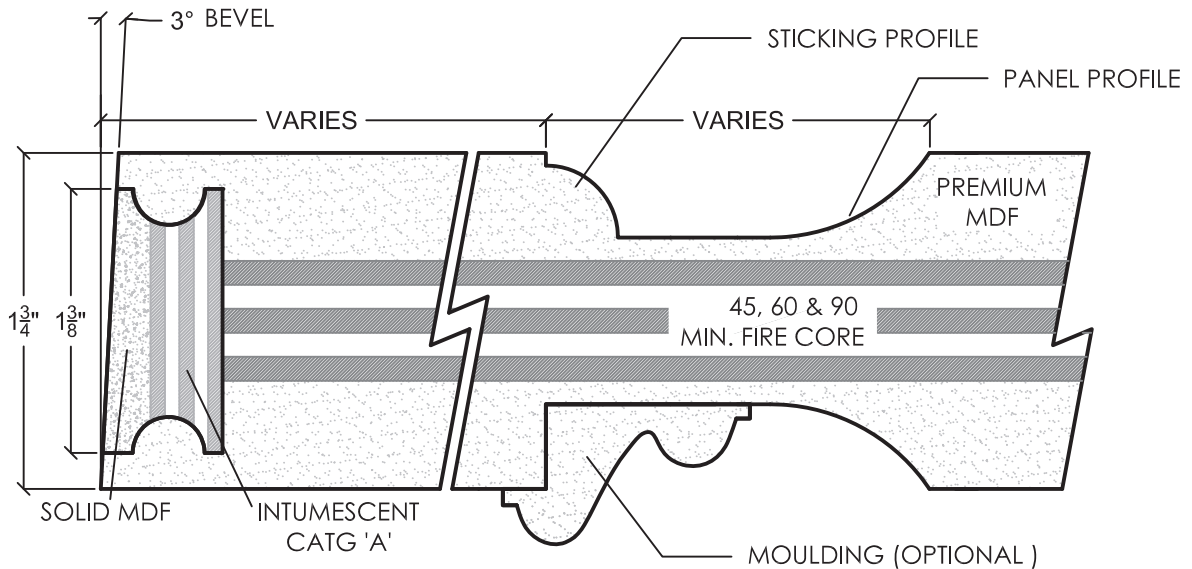

AVAILABLE IN ANY WOOD VENEER

STANDARD DIMENSIONS:

THICKNESS	1-3/4" & 2-1/4" (± 1/16")
WIDTH	1/4 - 3/6
HEIGHT	6/8, 7/0, 8/0

APPROXIMATE WEIGHT: (Based on 90 Min. 1 3/4" thickness)

	6/8	7/0	8/0	
1/6	89	94	107	(in lbs)
2/0	119	125	143	
2/4	139	146	167	
2/8	159	167	191	
3/0	179	188	215	

MACHINING:

* Factory-machining available to exacting requirements for hardware

FACTORY FINISH:

- * Doors are available with catalyzed varnish/polyurethane factory finish
- * Color choices are available or custom color matching by submitting a physical sample
- * All factory finished doors have sealed top & bottom rails



Door Style DS-10
Factory Finish Horizontal Quarter-Cut Maple Veneer with Reset Walnut Veneer Detail



Trim Detail
Stained Walnut Riviera
Casing CA316DL &
B72DL Backband



Hardware Detail
Lock Style RP-405



Door Detail
Flush Slab with Solid Walnut Reset Inlay

Available fire rated 20, 45, 60 & 90 minute
Available up to STC 36

Door Style DS-19

The Wynn & The Wynn Encore Suite Entry Door Factory Finish Solid MDF



Trim Detail
Stained Poplar Century
CA303DL Casing
& B74DL Backband



Hardware Detail
Lock Style RP-106



Door Detail
Custom Bevelled Panel

Available fire rated 20, 45, 60 & 90 minute
Available up to STC 36



Majestic MDF Door Specifications

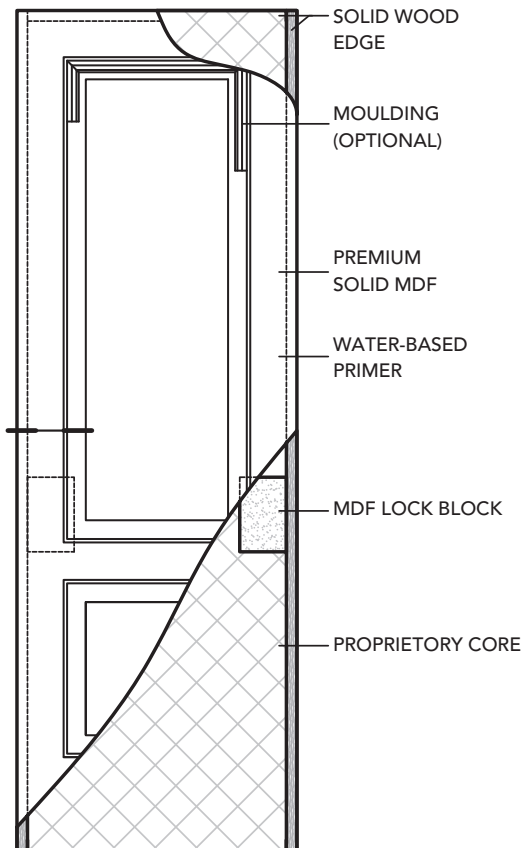
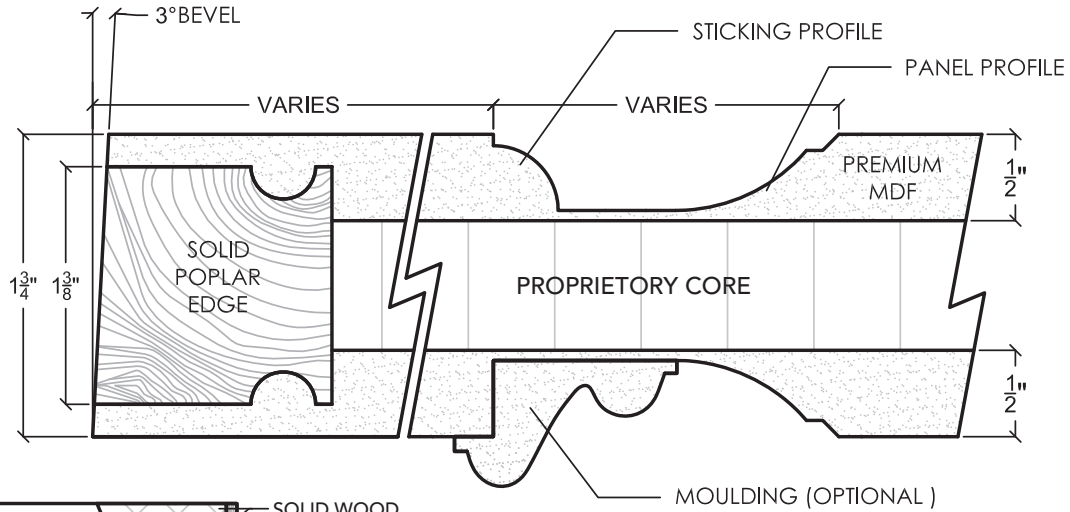

STANDARD DIMENSIONS:

THICKNESS	1-3/8", 1-3/4" & 2-1/4" ($\pm 1/16"$)
WIDTH	1/4 - 4/0
HEIGHT	6/8, 7/0, 8/0

(Higher Doors Available Upon Request)

APPROXIMATE WEIGHT: (Based on 1 3/4" thickness)

	6/8	7/0	8/0
1/6	41	43	48
2/0	53	56	64
2/4	62	65	74
2/8	71	74	84
3/0	79	83	95

(in lbs)

MACHINING:

* Factory-machining available to exacting requirements for hardware

FACTORY FINISH:

- * Doors are available with catalyzed varnish/polyurethane factory finish
- * Color choices are available or custom color matching by submitting a physical sample
- * All factory finished doors have sealed top & bottom rails

Door Style DS-A-05
Majestic Custom Arch Top

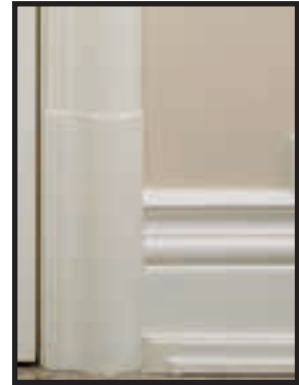

Trim Detail
Painted Poplar EastPark
Casing CA411DL &
Baseboard BB711DL



Hardware Detail
Lock Style CB21-P106



Door Detail
Luis Applied Moulding
Royal Panel



Some things you just can't let go



PEOPLE LOVE OUR DOORS

FACT:

In 1981, a Doorland client agreed to sell his home under the condition that he was able to take his front door.



Solid Wood Stile & Rail Door Specifications

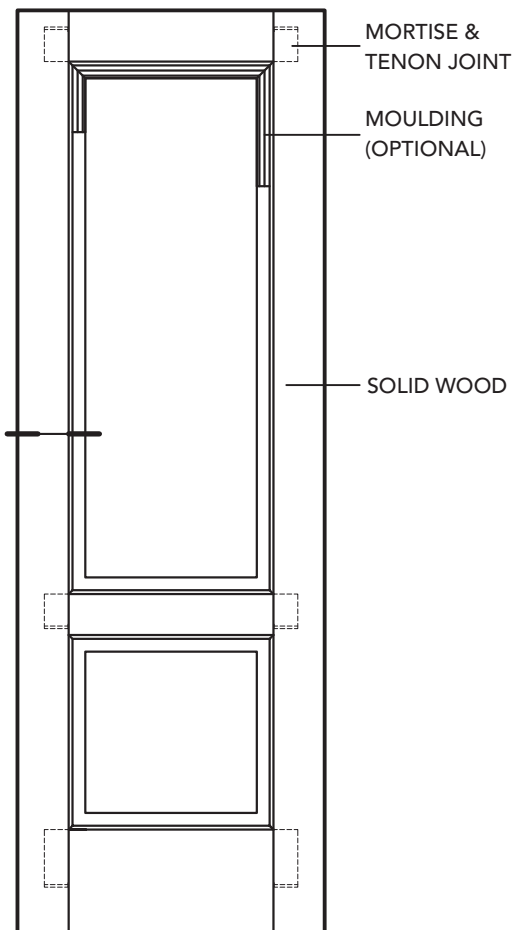
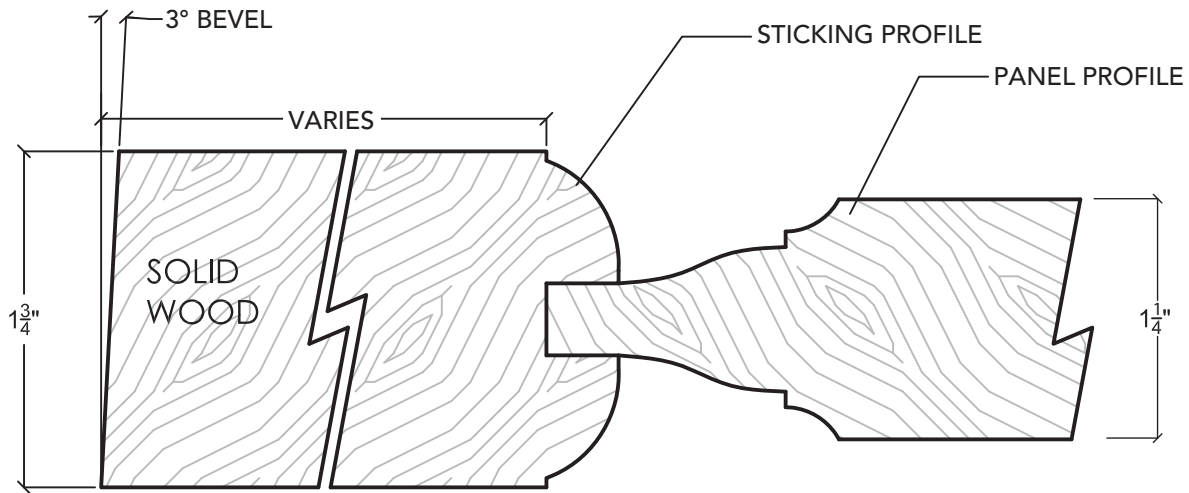

STANDARD DIMENSIONS:

THICKNESS	1-3/8", 1-3/4" & 2-1/4" ($\pm 1/16"$)
WIDTH	1/4 - 4/0
HEIGHT	6/8, 7/0, 8/0

(Higher Doors Available Upon Request)

APPROXIMATE WEIGHT: (Based on 1 3/4" thickness)

	6/8	7/0	8/0	
1/6	50	53	59	(in lbs)
2/0	65	68	78	
2/4	76	79	90	
2/8	86	90	102	
3/0	96	100	114	

MACHINING:

* Factory-machining available to exacting requirements for hardware

FACTORY FINISH:

- * Doors are available with catalyzed varnish/polyurethane factory finish
- * Color choices are available or custom color matching by submitting a physical sample
- * All factory finished doors have sealed top & bottom rails

Engineered Stile & Rail Solid Wood Door Specifications

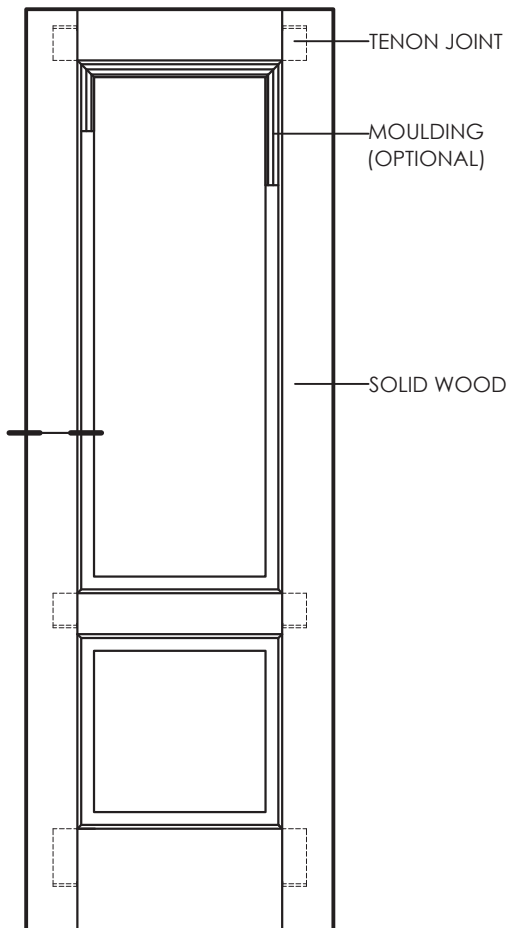
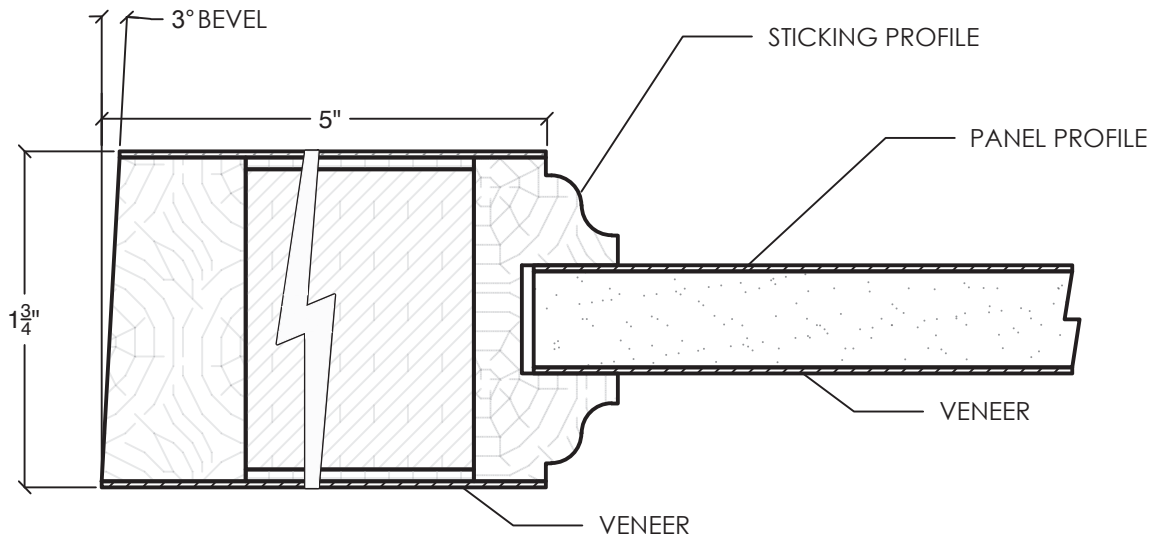

STANDARD DIMENSIONS:

THICKNESS	1-3/8", 1-3/4" & 2-1/4" ($\pm 1/16"$)
WIDTH	1/4 - 4/0
HEIGHT	6/8, 7/0, 8/0 <small>(Higher Doors Available)</small>

APPROXIMATE WEIGHT: (Lbs. based on 1 3/4" thickness)

	6/8	7/0	8/0
1/6	50	53	59
2/0	65	68	78
2/4	76	79	90
2/8	86	90	102
3/0	96	100	114

MACHINING:

* Factory machining available to exacting requirements for hardware

FACTORY FINISH:

* Doors are available with catalyzed Varnish / Polyurethane factory finish

* Color & Stain Choices are available or custom color matching by submitting a physical sample

* All Factory finished doors have sealed top & bottom rails

Door Style Custom S-04
Factory Finish Solid American Poplar/MDF Panels
Custom Radius Top



Trim Detail
Custom MDF Arch Eastpark
Casing CA411DL



Hardware Detail
Lock Style CB21-P106



Door Detail
Luis Applied Moulding
Royal Panel



Door Style DS-7
Factory Finish Solid Walnut, Antiqued & Distressed



Trim Detail
Stained Walnut Classic
Casing CA301DL

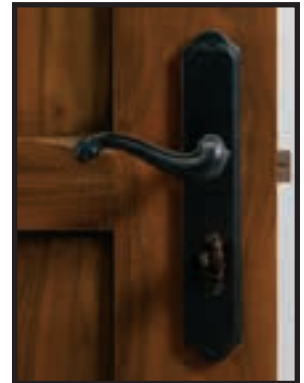

Hardware Detail
Lock Style RP-209

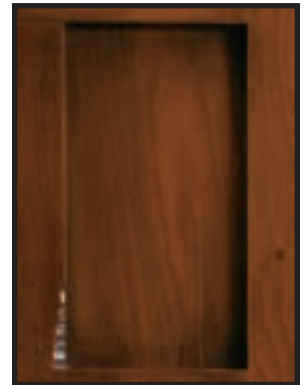

Door Detail
Shaker Sticking
Flat Panel

Door Style A-05
Factory Finish Natural Solid Knotty Pine



Trim Detail
Stained Knotty Pine Eastpark
Casing CA411DL &
Baseblock BA102DL &
Eastpark Baseboard BB711DL



Hardware Detail
Lock Style RP-609



Door Detail
Quarter Round Sticking
Royal Panel



Door Style DS-16-5
Factory Finish Solid Natural Walnut



Trim Detail
Doorland's Own Stained Walnut
Custom Profile
Casing CS404DL &
B81DL Backband

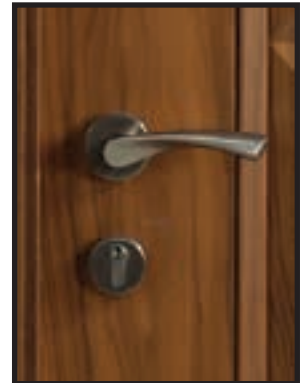

Hardware Detail
Lock Style RH-002



Door Detail
Modern Applied Moulding
Bevelled Panel

Door Style S-12
Factory Finish Solid Cherry with Light Curly Maple Panel



Trim Detail
Stained Cherry Century
Casing CA403DL



Hardware Detail
Lock Style RH-066



Door Detail
Shaker Sticking
Flat Panel



Door Style M-02
Factory Finish Solid Interior American Poplar Stained



Trim Detail
Stained Poplar Lincoln
Casing CA305DL &
B72DL Backband



Hardware Detail
Lock Style RP-208



Door Detail
Quarter Round Sticking
Royal Panel

Door Style E-04
Factory Finish Solid American Poplar Stained



Trim Detail
Stained Poplar Northern
Casing CA313DL &
B72DL Backband

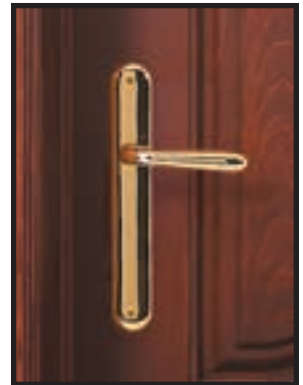

Hardware Detail
Lock Style AUR-133P8



Door Detail
Quarter Round Sticking
Royal Panel



Solid Wood Stile & Rail French Door Specifications

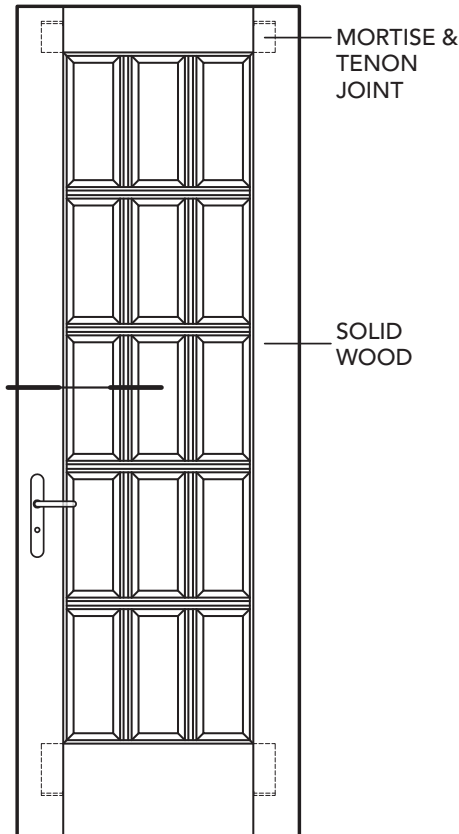
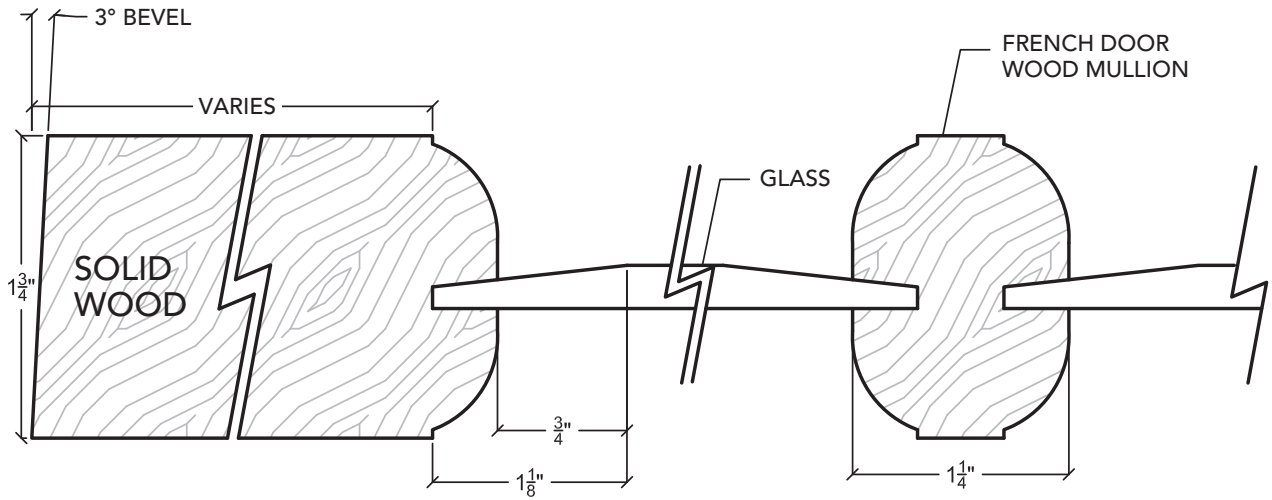

STANDARD DIMENSIONS:

THICKNESS	1-3/8" & 1-3/4" (± 1/16")
WIDTH	1/4 - 3/0
HEIGHT	6/8, 7/0, 8/0
GLASS TYPES	Please see catalog

APPROXIMATE WEIGHT:

	6/8	7/0	8/0
1/6	40	42	47
2/0	52	54	61
2/4	60	62	71
2/8	67	71	80
3/0	75	79	89

(in lbs)

MACHINING:

* Factory machining available to exacting requirements for hardware

FACTORY FINISH:

- * Doors are available with catalyzed varnish/polyurethane factory finish
- * Color choices are available or custom color matching by submitting a physical sample
- * All factory finished doors have sealed top & bottom rails

Door Style FD-747 Cortina Bevel Glass
Factory Finish Solid American Poplar Stained



Trim Detail
Stained Poplar Northern
Casing CA313DL &
B72DL Backband



Hardware Detail
Lock Style RP-208



Door Detail
Quarter Round Sticking
Royal Panel Bevelled Glass



Door Style S-03
Factory Finish Solid Interior American Poplar Stained Walnut



Trim Detail
Stained Poplar PE114DL
Pediment & Tudor
Casing CA325DL &
B77DL backband



Hardware Detail
Lock Style RP-609

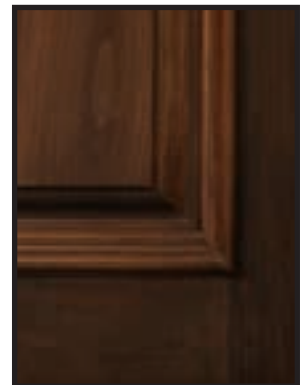

Door Detail
Luis Applied Moulding
Royal Panel

Factory Finish Pub Door in Solid African Mahogany

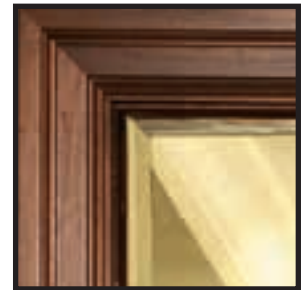

Trim Detail
Stained Mahogany Classic
Casing CA301DL



Glass Detail
Custom Etched Sandblasted

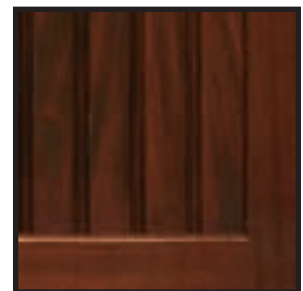

Door Detail
Quarter Round Sticking
Beaded Panel

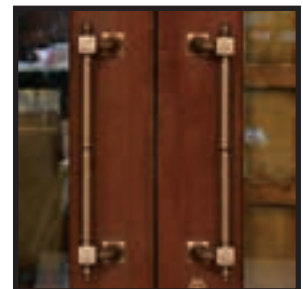

Hardware Detail
Custom Pulls



Louver Doors Specifications

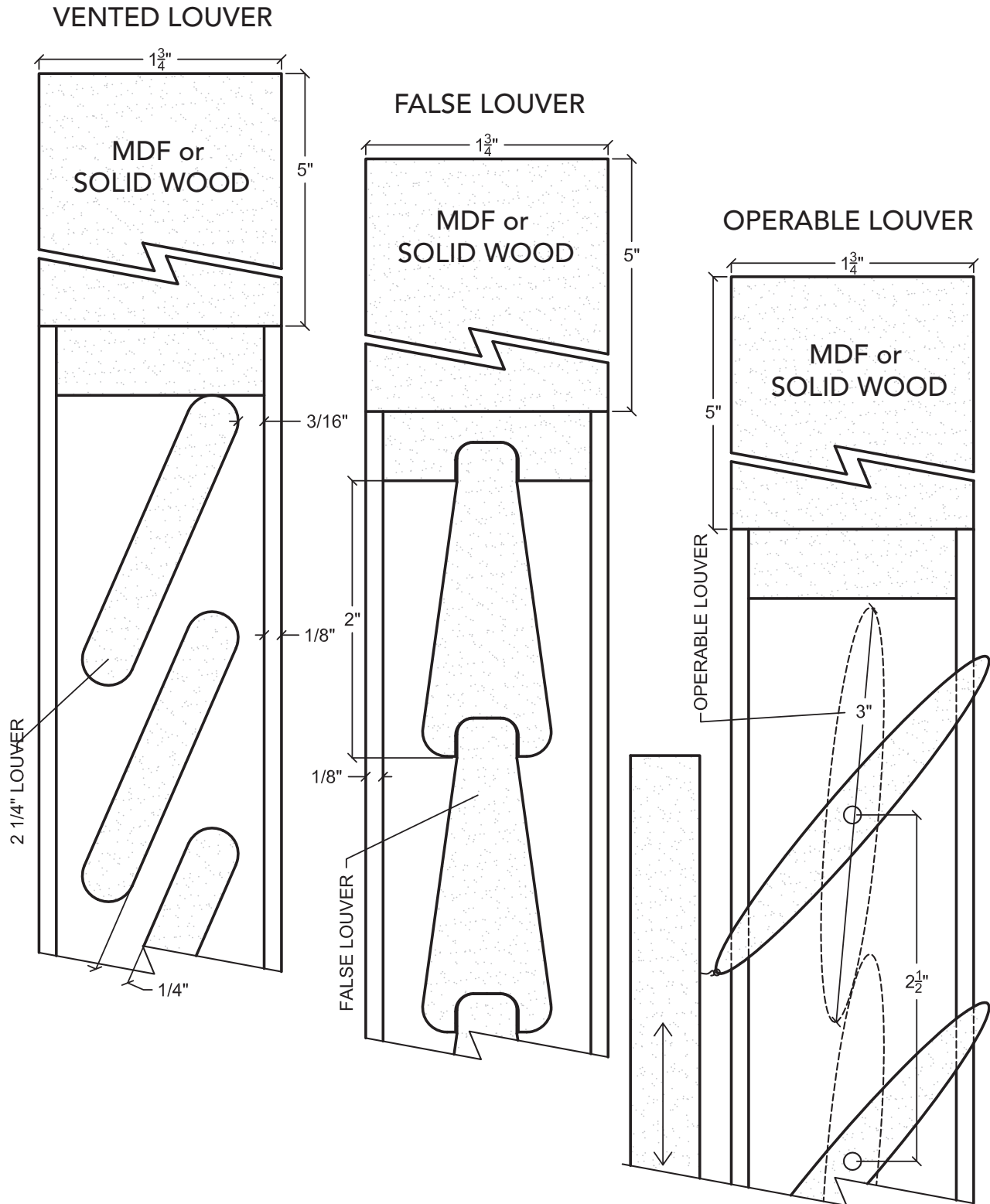

Door Style LV-01
Factory Finish Solid Walnut Vented Louver



Panel Detail
Modern Applied Moulding
Bevelled Panel



Louver Detail
Vented Louver
Shaker Sticking



Trim Detail
Northfield Baseboard BB725DL



Door Style LV-01
Factory Finish Solid Cherry Operable Louver



Trim Detail
Painted Poplar Century
CA303DL Casing &
B74DL Backband



Hardware Detail
Lock Style AUR850P8



Door Detail
Operable Louver
Shaker Sticking

Door Style LV-03
Factory Finish Solid MDF False Louver



Trim Detail
Painted Poplar Century
CA303DL Casing &
B74DL Backband



Hardware Detail
Lock Style RH-066



Door Detail
False Louver
Step Sticking



Solid Wood Stile & Rail Exterior Door Specifications

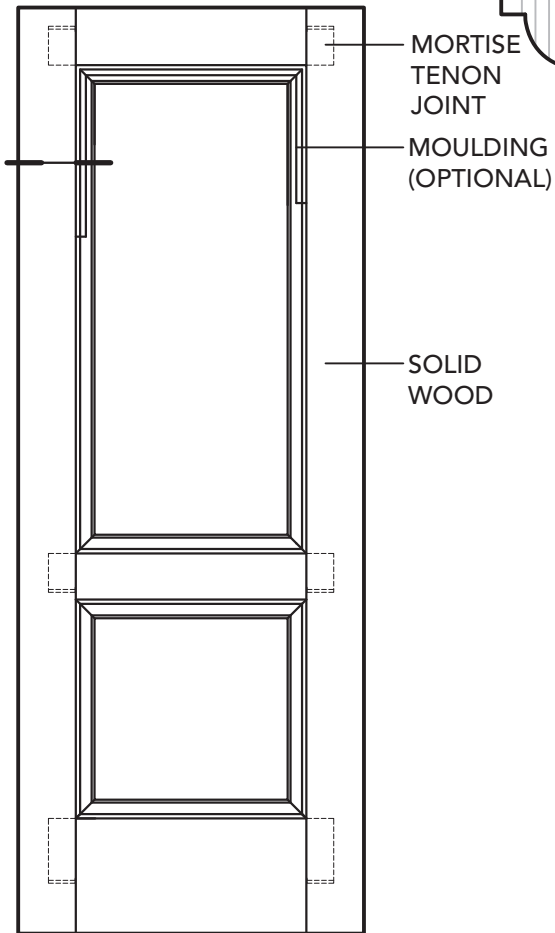
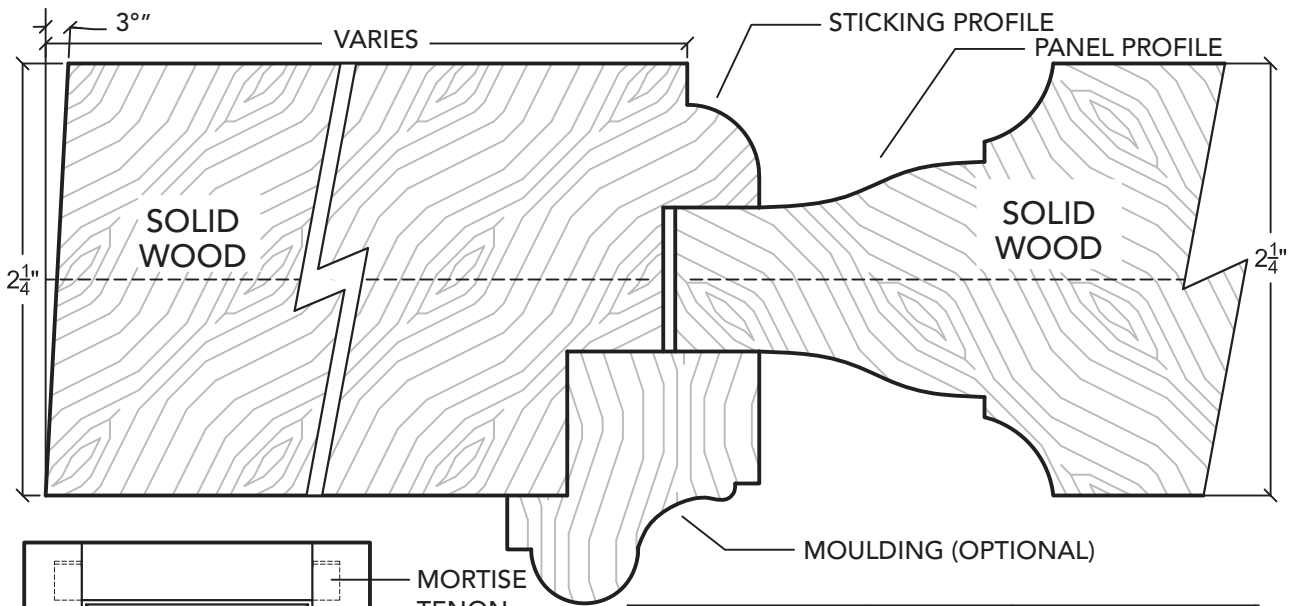

STANDARD DIMENSIONS:

THICKNESS	1-3/4 & 2-1/4" ($\pm 1/16"$)
WIDTH	2/8 - 4/0
HEIGHT	6/8, 7/0, 8/0
(Higher Doors Available Upon Request)	

APPROXIMATE WEIGHT: (Based on 2 1/4" thickness)

	6/8	7/0	8/0	
2/8	195	205	234	(in lbs)
3/0	220	231	264	
3/6	256	269	308	
4/0	293	308	352	

MACHINING:

* Factory-machining available to exacting requirements for hardware

FACTORY FINISH:

- * Doors are available with catalyzed varnish/ polyurethane factory finish
- * Color choices are available or custom color matching by submitting a physical sample
- * All factory finished doors have sealed top & bottom rails

Factory Finish Eagle's Nest Golf Club Door Unit in Solid African Mahogany



Carved Detail
Custom CNC Designed &
Carved Moulding



Door Detail
Custom Applied Moulding
Royal Panel

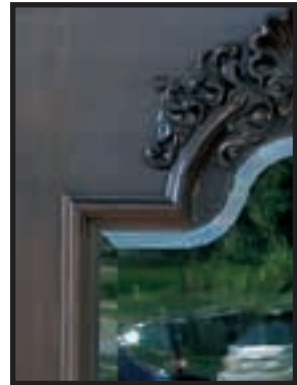

Glass Detail
Shaped Bevelled Thermo
Tempered Glass



Factory Finish Church Exterior Wood Doors In Solid Red Oak



Door Detail
Custom Designed Applied Moulding
Contemporary Panel



Hardware Detail
Custom Pulls

Factory Finish Custom Residential Unit in Solid Sapelle Mahogany

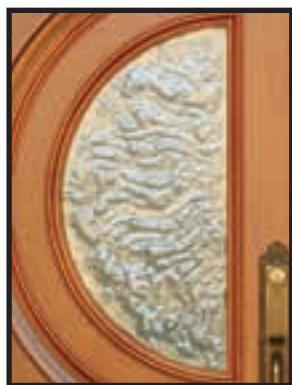

Glass Detail
Custom Melted Thermo
Tempered Glass



Hardware Detail
Lock Style REH-8209



Door Detail
Barocco Applied Moulding
Royal Panel



Factory Finish Custom Residential Solid Wood Door Unit with Carvings & Inlays in Solid Red Oak

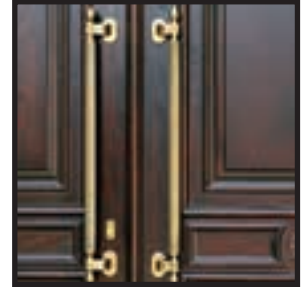

Door Hardware
Custom Pulls & Multi-Point
Locking System



Door Detail
Barocco Applied Moulding
Royal Panel



Door Detail
Custom Designed In-House



Door Detail
Custom Designed In-House

Factory Finish Custom Residential Solid Wood Door Unit with Melted Glass in Solid Walnut



Door Detail
Barocco Moulding



Door Hardware
Custom Pulls + Multi-Point
Locking System



Glass Detail
Custom Melted Thermo
Tempered Glass



Transom Detail
Custom Designed In-House



Factory Finish Custom Residential Solid Wood Door Unit
with Glass Accents Surrounds in Solid Sapelle Mahogany



Mahogany Tudor
Casing CA325DL &
B77DL Backband

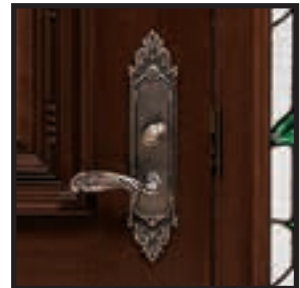

Hardware Detail
Lock Style The Chateau-Interior

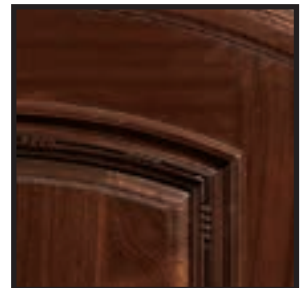

Door Detail
CNC Custom Applied Carved Moulding
Royal Panel

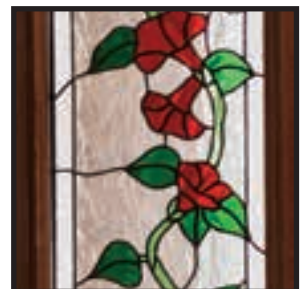

Glass Detail
Custom In-House Designed
Made Leaded Glass

Factory Finish Custom Residential Solid Wood Door Unit with Custom Leaded Glass in Solid Red Oak



Glass Detail
Custom In-House designed
Made Leaded Glass



Hardware Detail
Lock Style REH-8208



Door Detail
Barocco Applied Moulding
Royal Panel



Factory Finish Custom Residential Solid Wood Door Unit with Carving in Solid Red Oak



Door Detail
Custom Applied CNC
Carved Moulding Royal Panel



Hardware Detail
Custom Knob



Door Detail
Royal Panel with
Custom V-Groove Detail

Factory Finish Night Club/Lounge Door in Solid Sapelle Mahogany



Trim Detail
Stained Mahogany Custom Brickmould

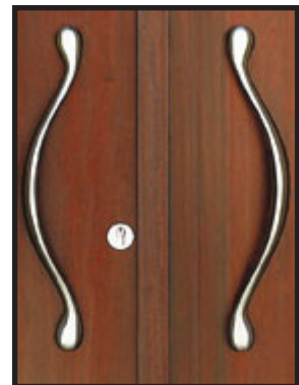

Door Hardware
Custom Pulls & Multi Point
Locking System

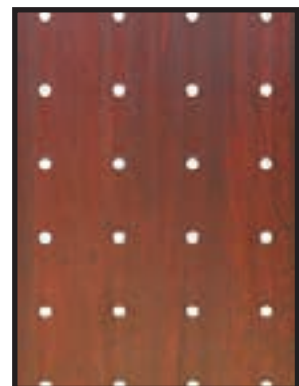

Door Detail
3/4 Recessed Stainless Steel Dowels



Factory Finish Custom Residential Exterior Side in Solid Teak

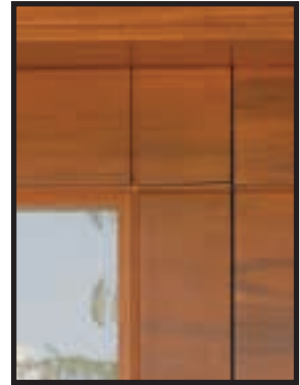

Door Detail
Flush Door with "U" Groove Detail



Hardware Detail
Custom Pull plus Multi-Point Hardware

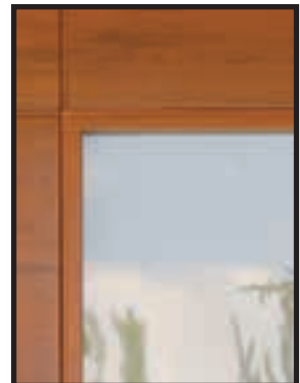

Glass Detail
Acid Etched Thermo Tempered

How Mouldings are Produced



1

Selected wood is mounted on a computerized laser-guided rip saw. The on-line computer determines the most efficient yield of wood.



2

Wood is cut to working size in preparation for the shaping stage.



3

A moulder machine takes care of surfacing (D4S) and actually shapes the wood to various moulding profiles.



4

The shaped wood profile exits the moulder ready for stain or paint.



Trim Moulding Profile Samples

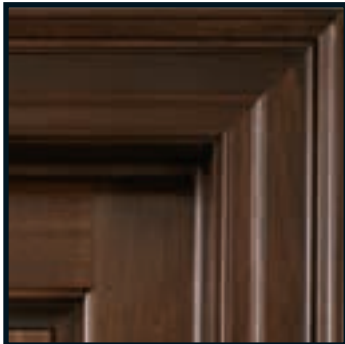

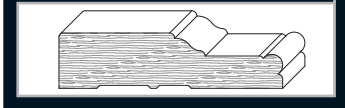

Tudor Casing
CA352DL 3/4" x 3 1/2"
19mm x 89mm



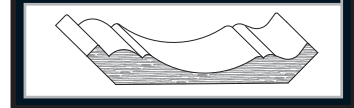

Pediment
PE114DL 1 3/4" x 7 1/4"
44mm x 184mm

Cove Moulding
C002DL 3/4" x 5 3/16"
19mm x 132mm



Lakeview Baseboard
BB717DL 13/16" x 7 1/4"
21mm x 184mm

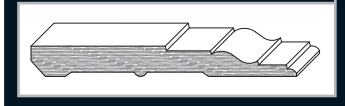
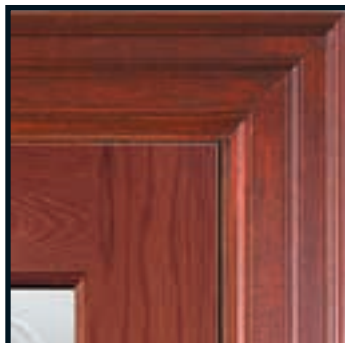

Classic Casing
CA301DL 3/4" x 3 1/2"
19mm x 89mm

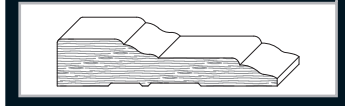
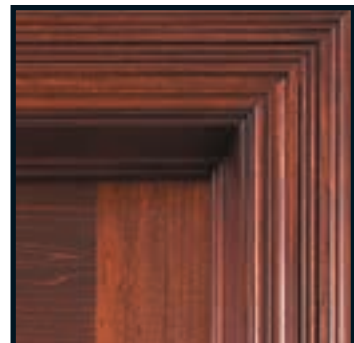
Northern Casing
CA313DL 3/4" x 3 1/2"
19mm x 89mm

Corner Block
BA102DL 1 5/8" x 4 1/2"
41mm x 114mm

Julia Casing
CS402DL 1 1/4" x 4"
32mm x 101mm

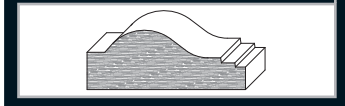



Eastpark Casing
CA411DL 1 1/4" x 4 1/4"
32mm x 108mm

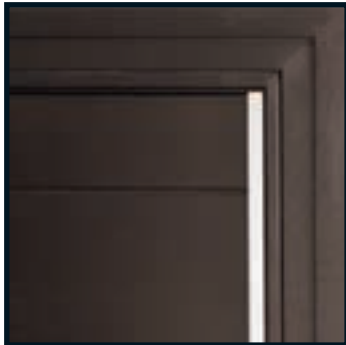

Our Mouldings

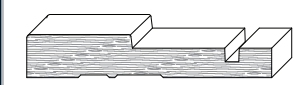

Groove Casing
CA432DL 3/4" x 4 1/4"
 19mm x 108mm



Northern Baseboard
BB513DL 3/4" x 5 1/4"
 19mm x 133mm



Century Casing
CA303DL 3/4" x 3 1/2"
 19mm x 89mm

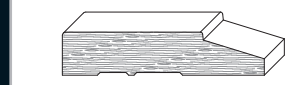

Tudor Casing & Backband
CA352DL & B77DL

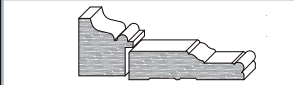

Georgina Casing
CA320DL 3/4" x 3 1/2"
 19mm x 89mm

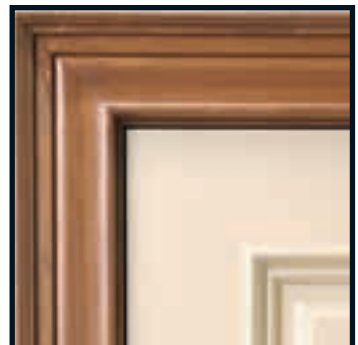

CA326DL 3/4" x 3 1/2"
 19mm x 89mm



Eastpark Baseboard
BB711DL 3/4" x 7 1/4"
 19mm x 184mm

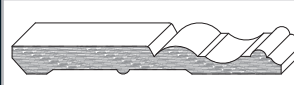

Window Sill & Nosing
SN102DL & SN105DL

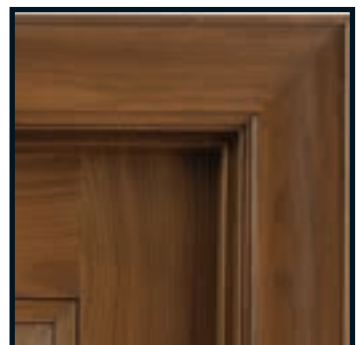

Doorland Casing & Backband
CS404DL & B81DL





45, 60, 90 Min., Fire Rated JAMB Specifications

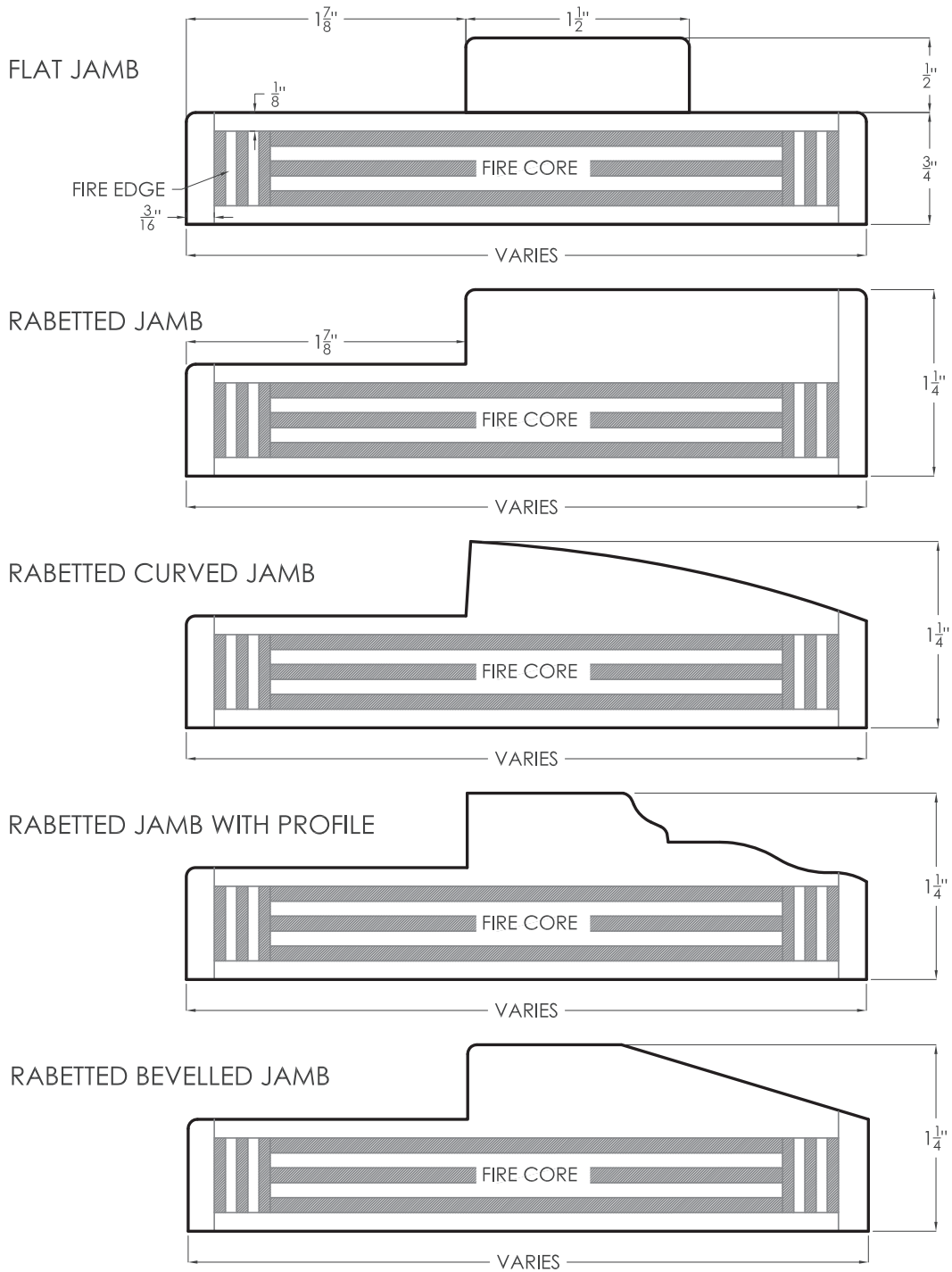

Available in primed MDF, Solid Wood & Exotic Veneers

JAMB Specifications

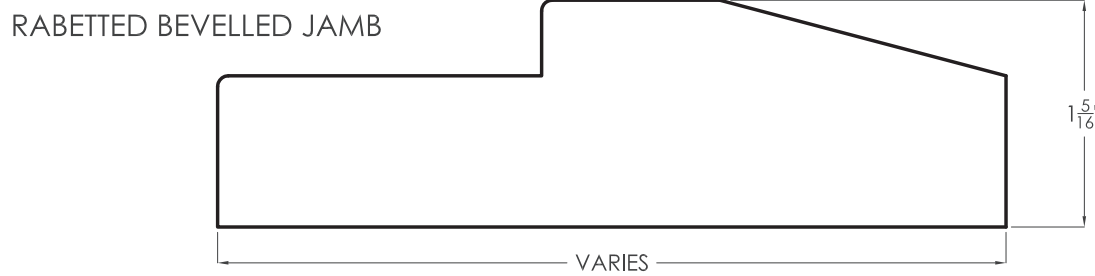
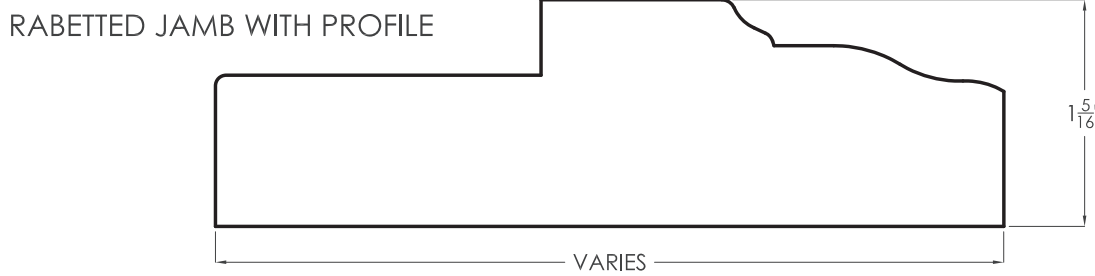
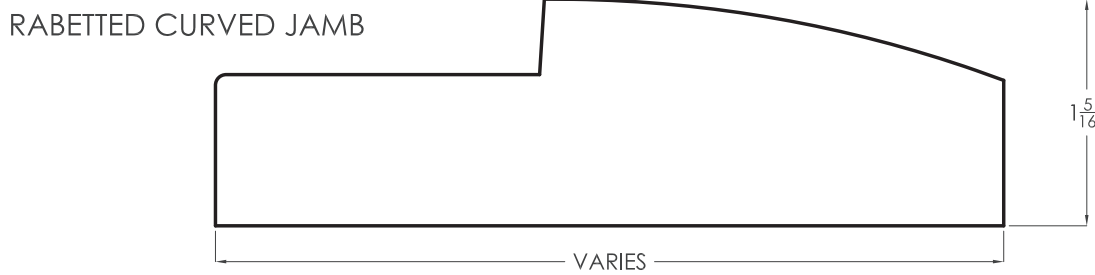
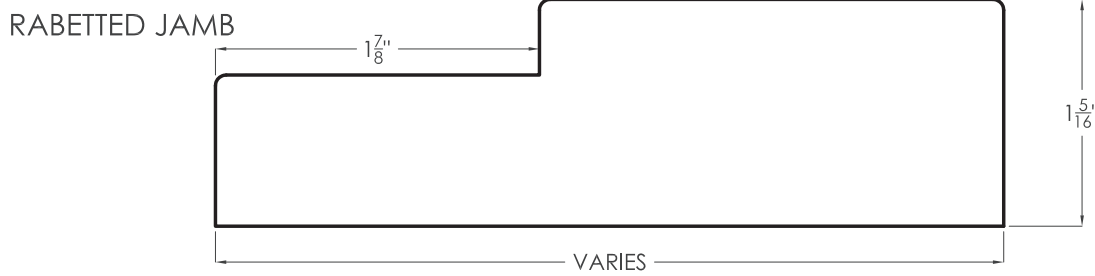
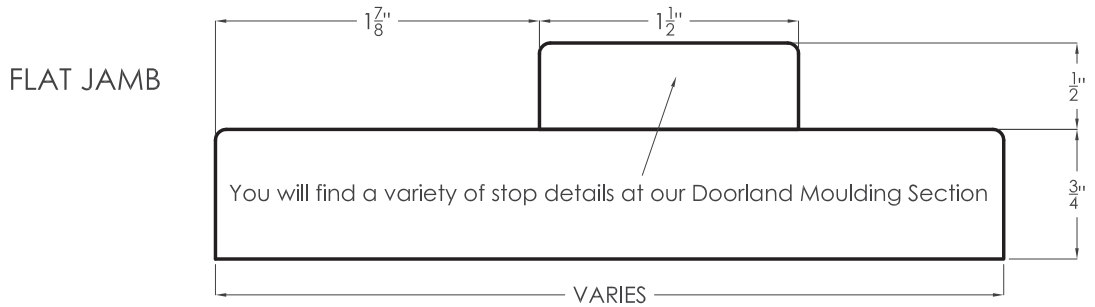

All Above JAMBS available in 20, 45, 60, 90 minute fire rating
 Available in primed MDF, Solid Woods & Exotic Veneers



Our state-of-the-art factory finishing line is an automated process which is capable of finishing doors in solid color, stain, sealer and lacquer, for both interior and exterior doors.

Traditional trade finishing methods rely heavily on site conditions and workmanship. These factors can compromise the finish and the overall integrity of the door. The Doorland factory finished door is produced in a controlled environment, where advanced machinery and qualified staff ensure a superior finish for each and every door.

Factory finishing adds value and beauty to living spaces. A well-finished door can be created to accent the overall style and décor of a living area, much like a piece of well-crafted furniture.

Factory Finishing Features:

- Produced in-house
- State-of-the-art machinery
- 2 stages of sanding and primer
- Solid and custom colors
- Stain, sealer and lacquer
- All doors sealed top and bottom
- Interior and exterior doors

Factory Finishing Benefits:

- Streamlined processes to improve efficiency and cost
- Produced in a controlled environment
- No exposure to external elements
- Preservation of the integrity and quality of the door
- Minimizes color inconsistencies
- Preferable process over site finishing
- Adds style, consistency to décor

Factory Finish



Our Premium Factory Finish

To ensure each and every door measures up to the Doorland standards of consistency and superior finish, our quality assurance team meticulously inspects the doors on all six sides. These scheduled quality checks are conducted throughout the factory finishing process. Our factory finished doors arrive on-site as per specification and are ready for installation.

How it's done?

- Step 1.** The unfinished door is placed into an automated conveyer system where the factory finishing process begins.
- Step 2.** The door is put through a pre-sanding stage, where only the surface is sanded.
- Step 3.** After the pre-sanding is complete, the door enters a denibbing machine, where only the raised panels are sanded.
- Step 4.** Once the surface and the raised panels are sanded, the door is put through a vacuum system where any dust and wood particles are removed.
- Step 5.** The sanded and cleaned door is sent to a preheating chamber. Preheating will allow the primer and paint to adhere suitably for the desired finish.
- Step 6.** Once the door reaches the desired temperature, it enters the spray line where the automated spray guns apply an even amount of primer and paint.
- Step 7.** The primed and painted door is stacked into a drying oven.
- Step 8.** Once the primer and paint are dry, the door enters a cooling chamber where it is inspected for cracks or imperfections.
- Step 9.** After careful inspection, the door travels through a final denibbing sanding stage where all excess primer is removed.
- Step 10.** Once the excess primer is removed, the door enters an automated flipping system where it is flipped and the whole process is repeated.
- Step 11.** Upon completion of the factory finishing process, all doors are inspected and approved by our quality assurance team.



Door Styles

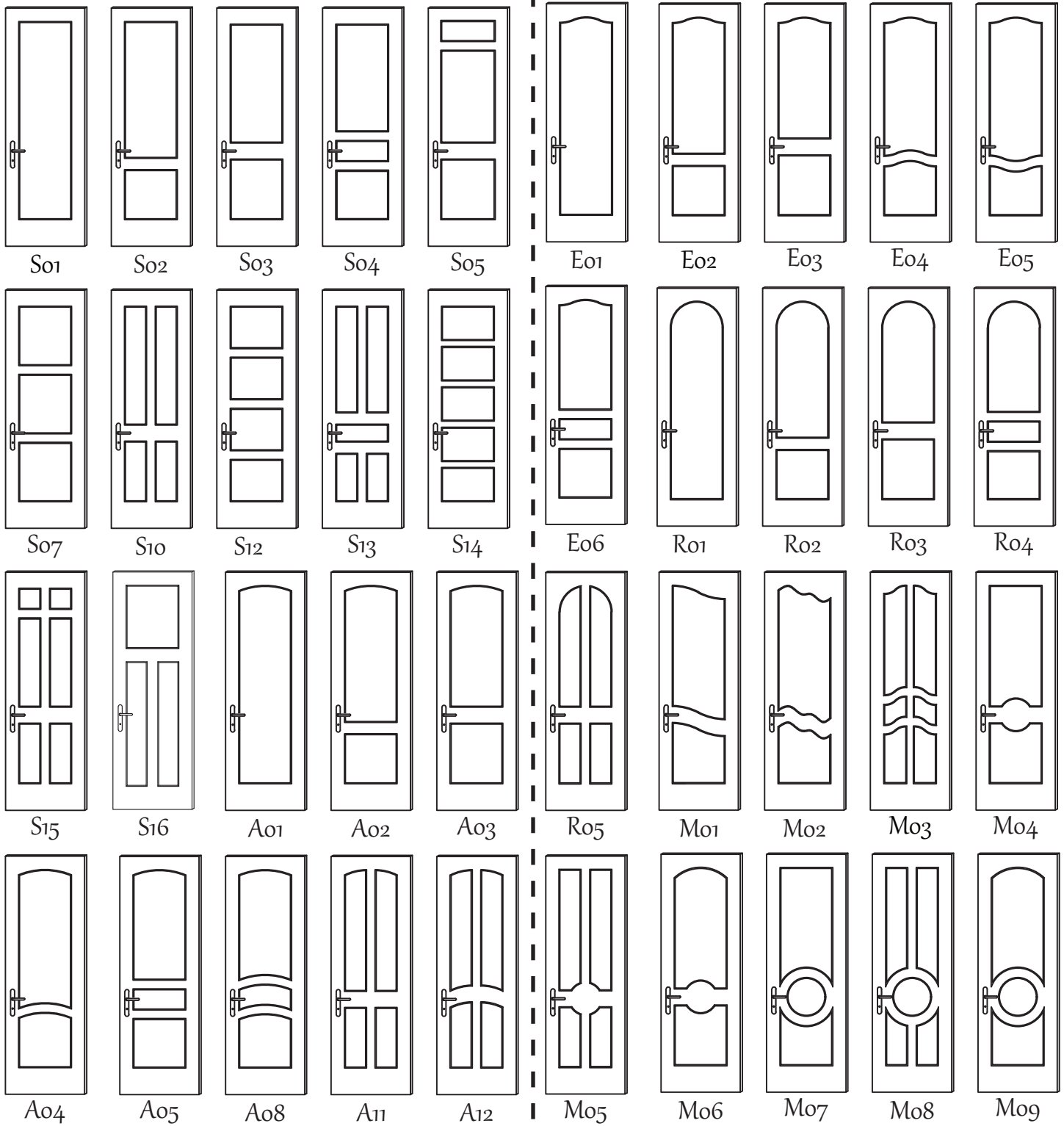

Typical Doorland door styles shown, Custom Designs and Sizing also available.

Door construction availability varies with Solid Wood, MDF, SCL, Extira, their composites, and the door style used.

Door Styles

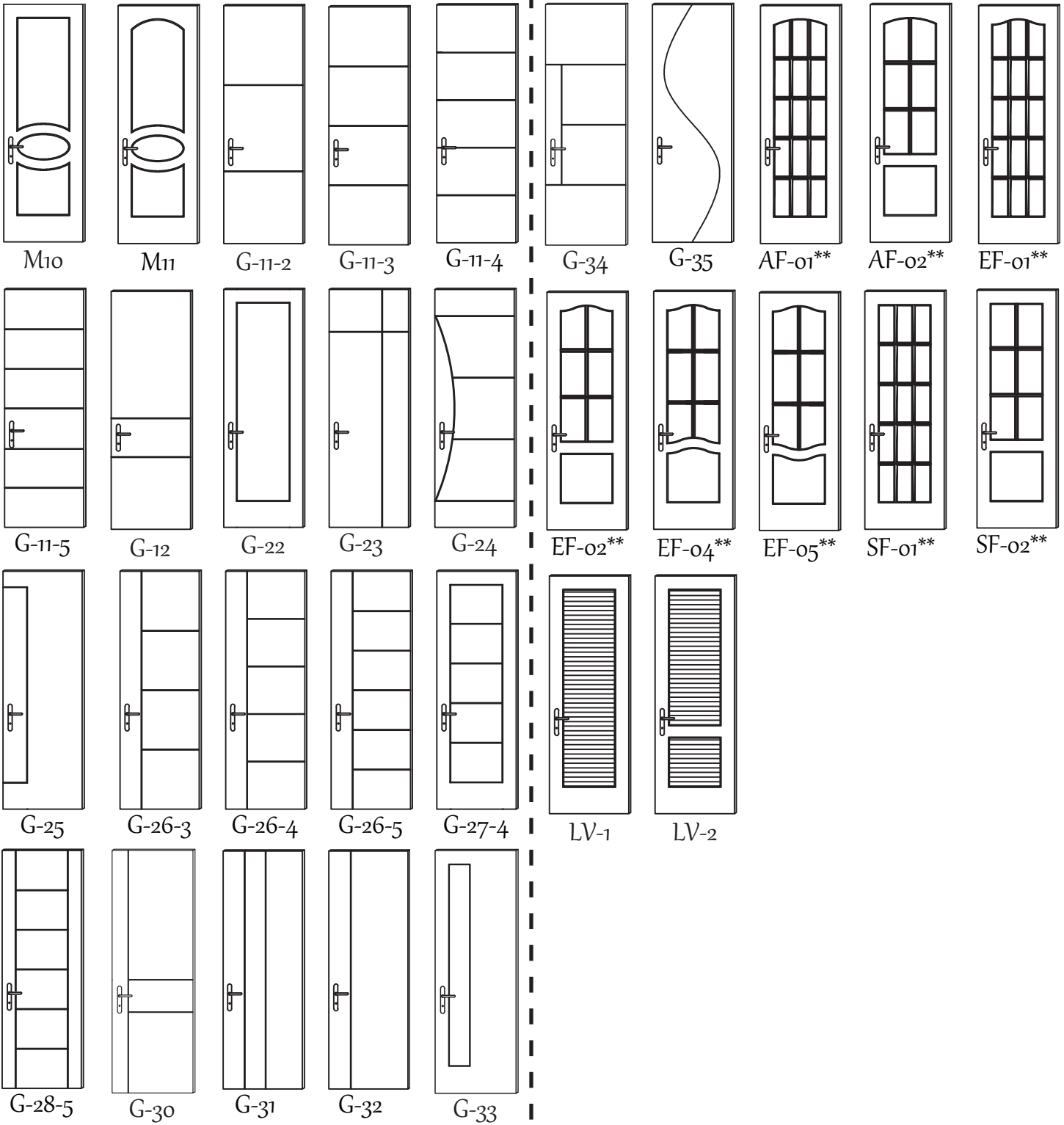

Typical Doorland door styles shown, Custom Designs and Sizing also available.

Door construction availability varies with Solid Wood, MDF, SCL, Extira, their composites, and the door style used.

**FRENCH DOORS AVAILABLE IN MULTIPLE DESIGNS- CONTACT OFFICE FOR DETAILS



Sticking Profiles

NOT ALL STICKING AVAILABLE IN ALL DOOR CONSTRUCTION. PLEASE SEE SALES REP.

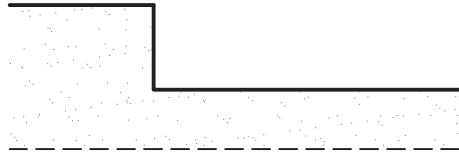

SHAKER STICKING (SHS)

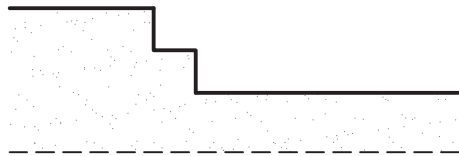

STEP STICKING (STS)

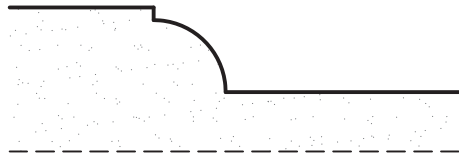

QUARTER ROUND STICKING (QRS)

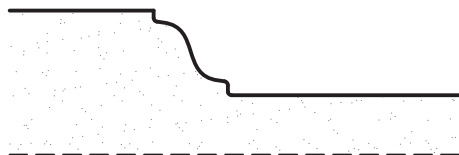

OGEE STICKING (OGS)

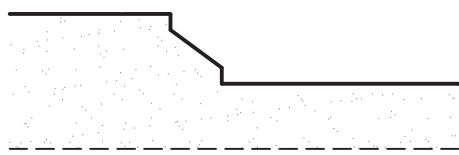

SMALL BEVELED STICKING (SBS)

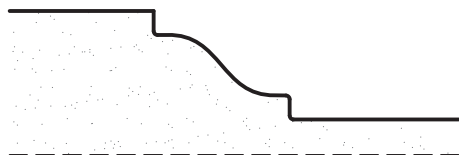

LONG OGEE STICKING (LOS)
NOT AVAILABLE IN MAJESTIC SERIES

Panel Profiles

NOT ALL STICKING AVAILABLE IN ALL DOOR CONSTRUCTION. PLEASE SEE SALES REP.

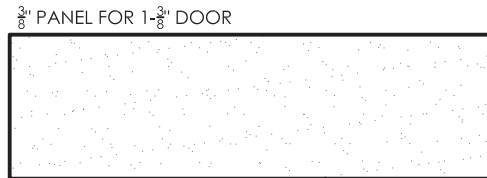

3/8" PANEL FOR 1-3/8" DOOR
3/4" PANEL FOR 1-3/4" DOOR
FLAT PANEL (FLP)
NOT AVAILABLE IN MAJESTIC SERIES

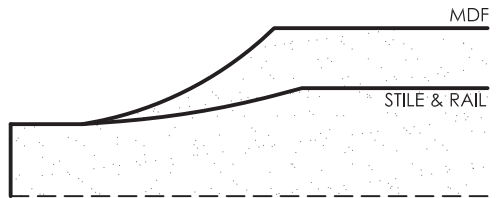

SCOOP PANEL (SCP)

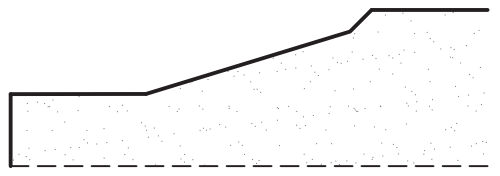

CONTEMPORARY PANEL (COP)

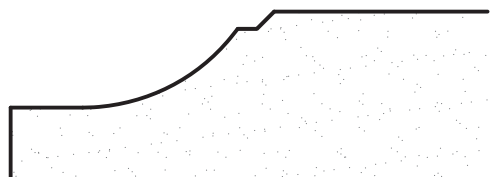

ARTISTIC PANEL (ARP)

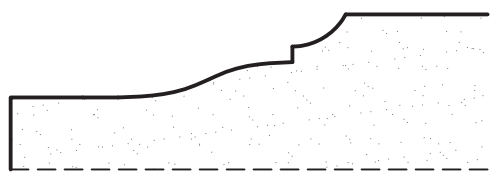

ROYAL PANEL (ROP)

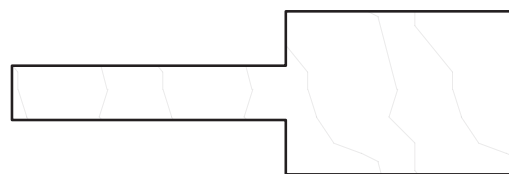

STEP PANEL (STP)

Groove Profiles

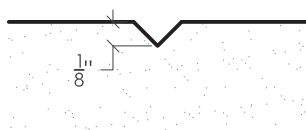

V GROOVE - 1/4" x 1/8"

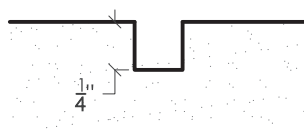

1/4" U GROOVE - 1/4" x 1/4"



1/2" U GROOVE - 1/2" x 1/8"

Applied Moulding

SOLID WOOD OR MDF

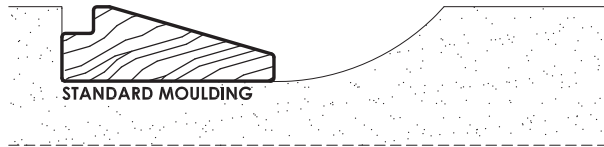

MODERN MOULDING (MOM)

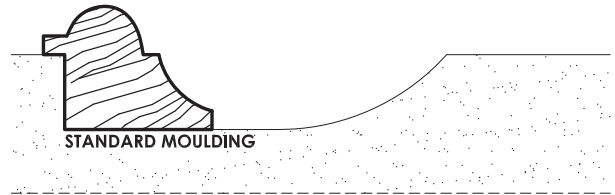

TOSCANA MOULDING (TOM)

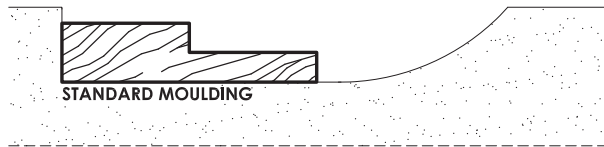

CONTEMPORARY MOULDING (COM)

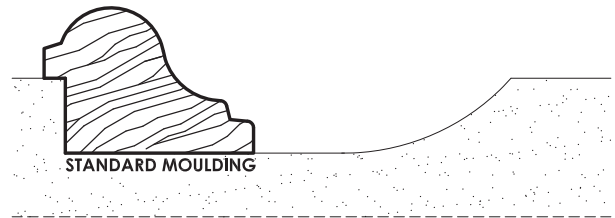

BAROCCO MOULDING (BAM)

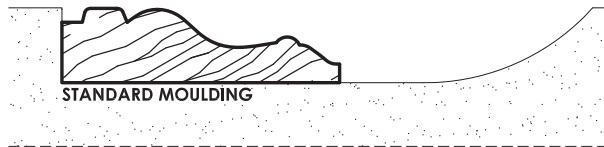

PROVINCIAL MOULDING (PRM)

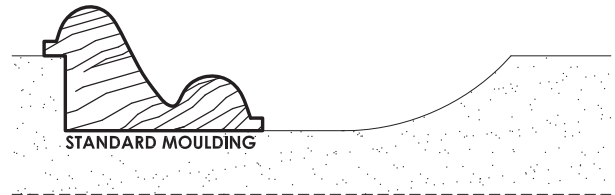

CLASSIC MOULDING (CLM)

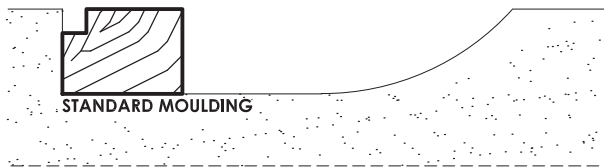

REVEAL MOULDING (RVM) M38DL

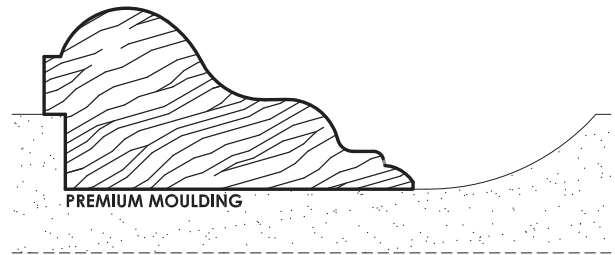

LUIS MOULDING (LUM)

List of World Wide Projects

THE WYNN

LAS VEGAS, NEVADA

THE PLAZA HOTEL

NEW YORK, NEW YORK

THE MARK HOTEL

NEW YORK, NEW YORK

COPLEY SQUARE HOTEL

BOSTON, MASSACHUSETTS

UNIVERSAL STUDIOS

ORLANDO, FLORIDA

RITZ CARLTON

BALTIMORE, MARYLAND

MANHATTAN BEACH MARRIOTT

MANHATTAN BEACH, CALIFORNIA

THE ARTISAN

ATLANTA, GEORGIA

HILTON GARDEN INN

CHARLOTTE, NORTH CAROLINA

"W" HOTEL

MIAMI BEACH, FLORIDA

St. REGIS HOTEL

FT. LAUDERDALE, FLORIDA

FANTASY SPRINGS CASINO

INDIO, CALIFORNIA

RENAISSANCE HOTEL

BALTIMORE, MARYLAND

CEASARS OCTAVIUS TOWER

LAS VEGAS, NEVADA

CHUCKCHANSI CASINO

COARSEGOLD, CALIFORNIA

ONE THOUSAND OCEAN

BOCA RATON, FLORIDA

PRINCE ARTHUR RESIDENCES

TORONTO, ONTARIO

THE BELLARIA

MAPLE, ONTARIO

THE REGENCY

YORKVILLE, ONTARIO

THE RENAISSANCE

MAPLE, ONTARIO



QUESTIONS?

Get your answer to doors online at
www.doorlandgroup.com



Even More World Wide Projects

THE WYNN ENCORE
LAS VEGAS, NEVADA

**EAGLES NEST GOLF AND
COUNTRY CLUB**
TORONTO, CANADA

St. CLAIRE OF ASSISI CHURCH
TORONTO, CANADA

ANAHEIM MARRIOTT
ANAHEIM, CALIFORNIA

RADISSON HOTEL
NEWPORT BEACH, CALIFORNIA

THE FONTAINEBLEAU RESORT
MIAMI BEACH, FLORIDA

THE PLAZA SUITES
SANTA CLARA, CALIFORNIA

LIMELIGHT HOTEL & LODGE
ASPEN, COLORADO

VALLAGIO NORTH
DENVER, COLORADO

VILLAGE AT OCOTILLO
CHANDLER, ARIZONA

WEST BROADWAY
NEW YORK, NEW YORK

**WYNDHAM NATIONAL
HARBOR RESORT**
OXON HILL, MARYLAND

EPIC HOTEL
MIAMI, FLORIDA

HILTON SAN DIEGO RESORT
SAN DIEGO, CALIFORNIA

**GAYLORD NAT. HOTEL &
CONVENTION CENTER**
BALTIMORE, MARYLAND

SOHO LOFTS
LAS VEGAS, NEVADA

JW MARRIOTT
HOUSTON, TEXAS

JW MARRIOTT STARR PASS
TUCSON, ARIZONA

LAX MARRIOTT
LOS ANGELES, CALIFORNIA

MARINA DEL REY MARRIOTT
MARINA DEL REY, CALIFORNIA

**MARRIOTT PORTLAND
CITY CENTER**
PORTLAND, OREGON

NEWPORT BEACH MARRIOTT
NEWPORT BEACH, CALIFORNIA

St. REGIS HOTEL
DEER VALLEY, UTAH

WATERFORD RESIDENCES
TORONTO, ONTARIO

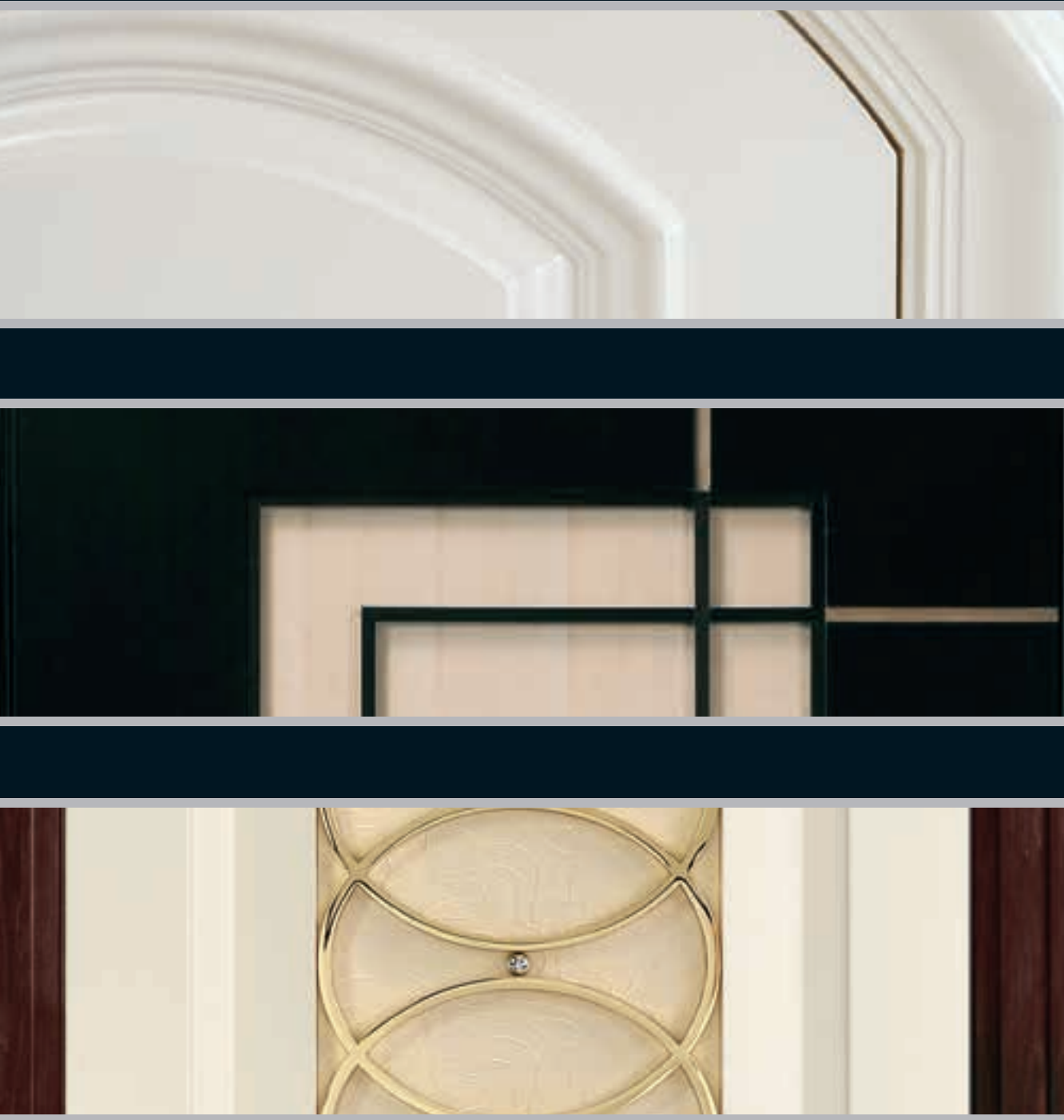

YOUR ANSWER TO DOORS SINCE 1979

SOLID WOOD STILE & RAIL DOORS MDF & FIRE RATED DOORS SOLID WOOD MOULDINGS

Doorland Group.
221 Creditview Road
Woodbridge, ON
Canada L4L 9T1

Toll: 1.800.265.0379 Web: www.doorlandgroup.com

Built to Spec. Built for You.

